

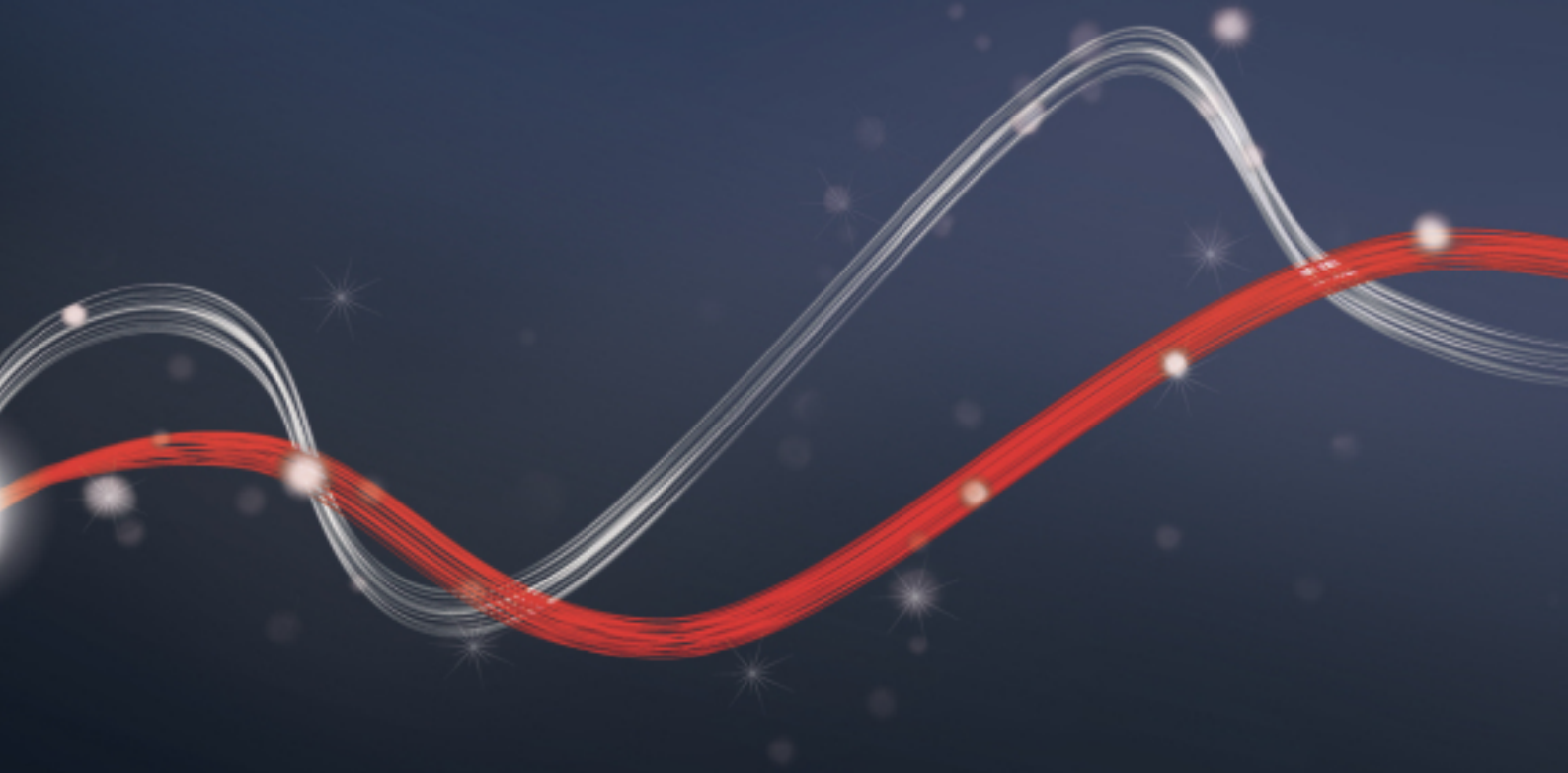

Be ahead



Ranch B



• Product

• TECHNICAL FEATURES

• ACCESSORIES

• DISCOVER U-LINK

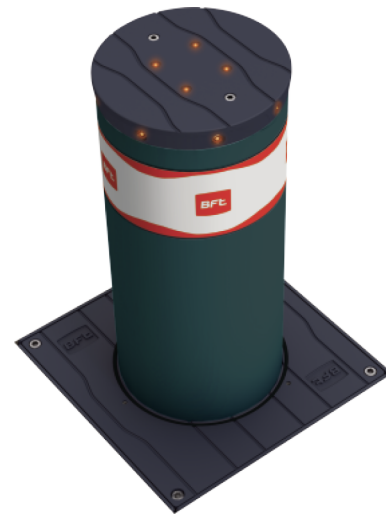

Ranch B | |

Code	Name	Description
P970081 00001	RANCH B 219/500	Fixed bollard with rod diameter and height 500 mm. Fixed bollard with shaft diameter 220 and height 500 mm. RAL 7015 painted steel version
P970081 00003	RANCH B 219/500 I	Fixed bollard with rod diameter and height 500 mm. Fixed bollard with shaft diameter 220 and height 500 mm. Stainless steel version
P970081 00002	RANCH B 219/500 L	Fixed bollard with shaft diameter and height 500 mm and lights. Fixed bollard with shaft diameter 220 and height 500 mm. RAL 7015 painted steel version with LED light cap
P970081 00004	RANCH B 219/500 LI	Fixed bollard with shaft diameter and height 500 mm and lights. Fixed bollard with shaft diameter 220 and height 500 mm. Stainless steel version with LED light cap
P970082 00001	RANCH B 219/700	Fixed bollard with rod diameter and height 700 mm. Fixed bollard with shaft diameter 220 and height 700 mm. RAL 7015 painted steel version
P970082 00003	RANCH B 219/700 I	Fixed bollard with rod diameter and height 700 mm. Fixed bollard with shaft diameter 220 and height 700 mm. Stainless steel version
P970082 00002	RANCH B 219/700 L	Fixed bollard with shaft diameter and height 700 mm and lights. Fixed bollard with shaft diameter 220 and height 700 mm. RAL 7015 painted steel version with LED light cap
P970082 00004	RANCH B 219/700 LI	Fixed bollard with shaft diameter and height 700 mm and lights. Fixed bollard with shaft diameter 220 and height 700 mm. Stainless steel version with LED light cap

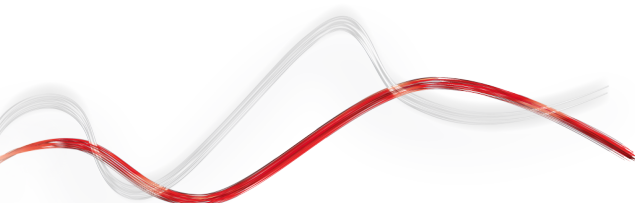

· Product

· TECHNICAL FEATURES

· ACCESSORIES

· DISCOVER U-LINK

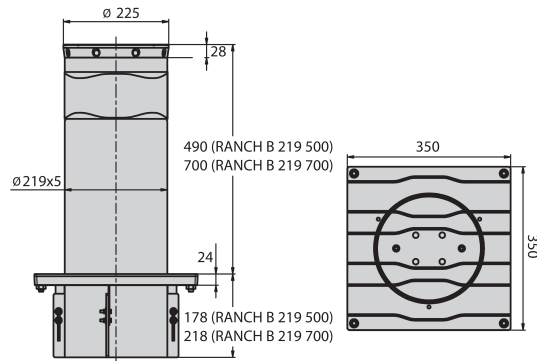

	RANCH B 219/500	RANCH B 219/500 I	RANCH B 219/500 L	RANCH B 219/500 LI	RANCH B 219/700	RANCH B 219/700 I	RANCH B 219/700 L	RANCH B 219/700 LI
Rod height	500 mm				700 mm			
Operator type	fixed bollards							
Rod diameter	220							
Rod thickness	3 mm							
Rod treatment	cataphoresis	stainless steel	cataphoresis	stainless steel	cataphoresis	stainless steel	cataphoresis	stainless steel
Rod fixing	3 bolts J							

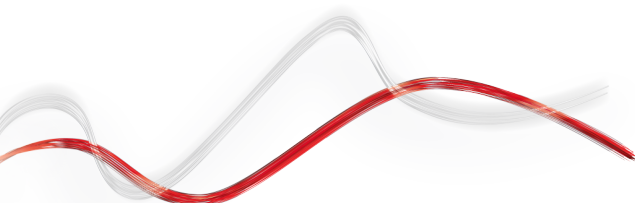



Ranch B



· Product

· TECHNICAL FEATURES

· **ACCESSORIES**

· **DISCOVER U-LINK**

	Code	Name	Description
	P800104	ALLU	Power supply for Gas and Fixed Bollards with Lights 24 Vac (up to 80 bollards)

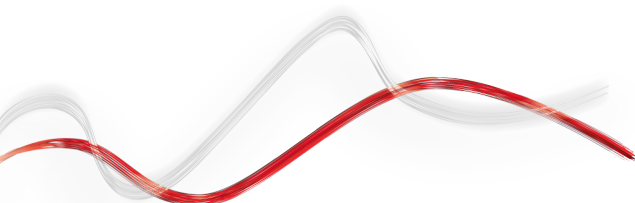



· Product

· TECHNICAL FEATURES

· ACCESSORIES

· DISCOVER U-LINK

What is U-Link?

The innovative technology that gives you new power

An exclusive Bft innovation: U-Link (Universal Link) is an exclusive Bft platform that allows the creation of technological ecosystems. In Home Automation Access, it allows communication with all the home access automation devices of any brand. So you save time and can control everything with ease, without any worries.

It is intuitive

Easy to install and use

It is scalable

Allows an unlimited number of devices to be added

It is flexible

Allows the creation of groups of interconnected products

It is practical

Works with or without a web connection

It is functional

Parameters can be controlled remotely via dedicated applications

· Product

· TECHNICAL FEATURES

· ACCESSORIES

· DISCOVER U-LINK

All in one scheme: discover this amazing technology

A unique platform **allowing the creation of technological ecosystems** offering a wide range of solutions for different sectors.

Thanks to the B-Eba cards and the Clonix U-Link receiver, this proprietary platform featured by Bft products adapts to any protocol and access automation product (even BFT, non-native U-Link or non-BFT products), and is used in various sectors. Each device thus becomes smart and can be interconnected with other systems, thanks to a language that becomes universal.

U-Base 2



Software to install and easily and comfortably carry out maintenance and identify any malfunction of U-link compatible operators.

U-SDK



U-SDK is the innovative application that can make Bft automation systems compatible and easily integrated with a BMS network for the supervision of buildings.



Magistro

An innovative and easy to install system for easily managing all home automation systems.



U-Control

U-Control is the application that helps the quick and easy integration of BFT automation systems in large building management systems.



Blue-Entry

Technology abreast of the times and attentive to daily needs: thanks to the use of U-link the house gate can now be opened with just your smartphone.



Clonix U-Link

Allows the connection of non-native U-Link products or non-Bft products to U-Link systems.

Bft operators, non-native U-Link products or a product belonging to other brands: can they be connected to U-Link? Yes, thanks to the Clonix receivers. Accessories that know no limits.

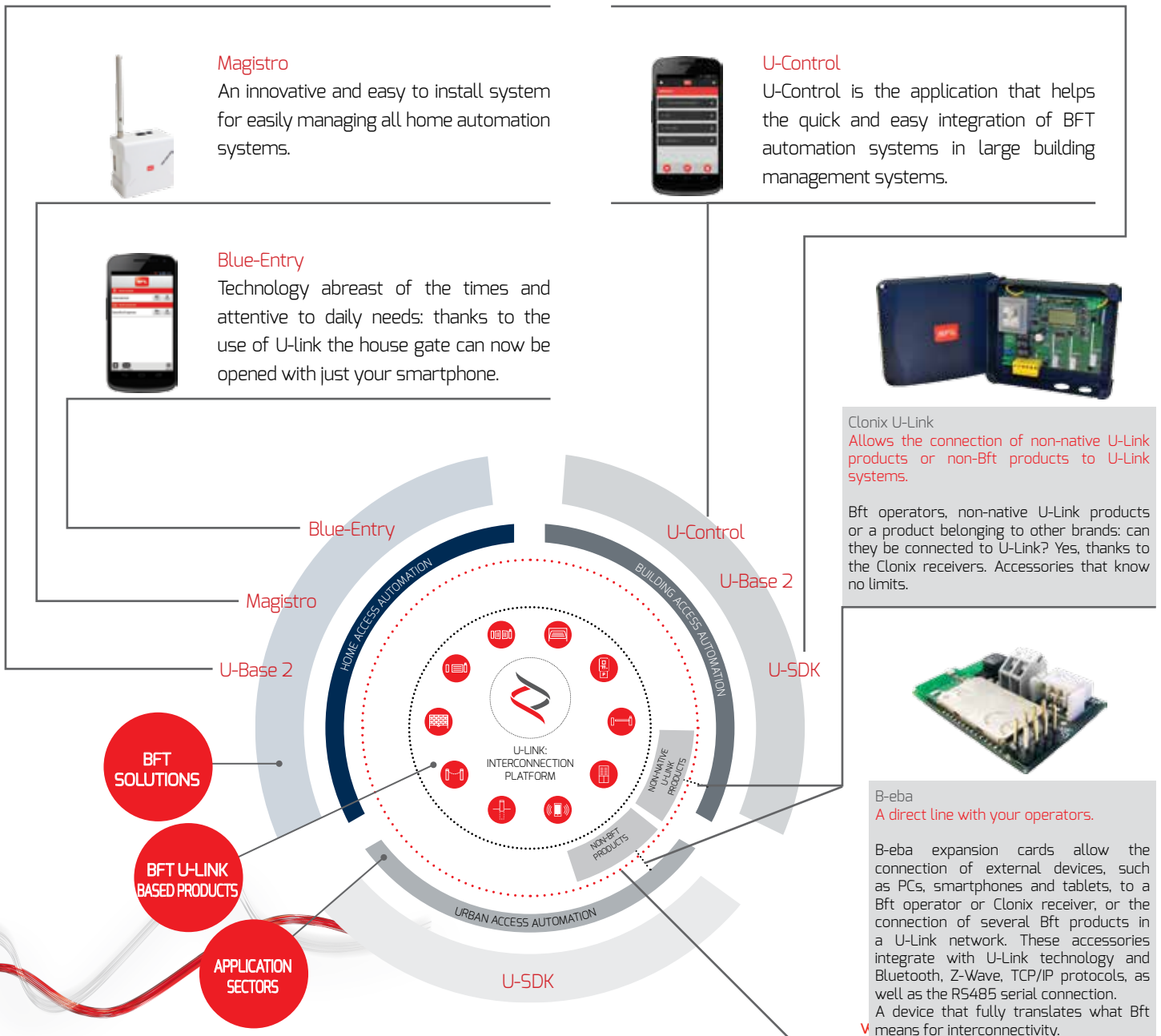

B-eba

A direct line with your operators.

B-eba expansion cards allow the connection of external devices, such as PCs, smartphones and tablets, to a Bft operator or Clonix receiver, or the connection of several Bft products in a U-Link network. These accessories integrate with U-Link technology and Bluetooth, Z-Wave, TCP/IP protocols, as well as the RS485 serial connection.

A device that fully translates what Bft means for interconnectivity.



INFORMATION REGARDING THE PROTECTION OF THE INDUSTRIAL AND INTELLECTUAL PROPERTY RIGHTS OF BFT. BFT S.p.A. protects its industrial property by depositing trademarks, patents, models and designs. The intellectual property of BFT S.p.A. is protected by copyright law. BFT S.p.A. also protects its know-how by taking measures to protect the technical and commercial information inherent in its company and products. All the products in this catalogue are ORIGINAL BFT MODELS and only BFT S.p.A is authorised to produce them and market them anywhere in the world. All the commercial names in this catalogue are owned by BFT S.p.A., and only BFT S.p.A. is authorised to use them in relation to the corresponding merchandise category. FALSIFIERS WILL BE PROCEEDED AGAINST IN ACCORDANCE WITH BOTH CIVIL AND CRIMINAL LAW. THESE CONDITIONS NOT ONLY GUARANTEE THE INTELLECTUAL PROPERTY RIGHTS OF BFT, BUT ALSO PROTECT CUSTOMERS BY GUARANTEEING THAT THE PRODUCTS THEY ARE PURCHASING ARE ORIGINAL BFT PRODUCTS RESULTING FROM STUDIES AND DESIGNS WITHIN THE BFT COMPANY.